

The A value in the table below for each bracket to mount on the door frame, shows the minimum requirement distance of the door frame for different electromagnetic lock model.

Magnet Grade	ValueA"	Option Brackets
300 LBS	38mm	L-150, L-EM150...
600 LBS	42mm	L-300, L-10001ST...
800LBS	48mm	L-750, L-350, L-400...
● 1200 LBS	60mm	L-500, L-600...

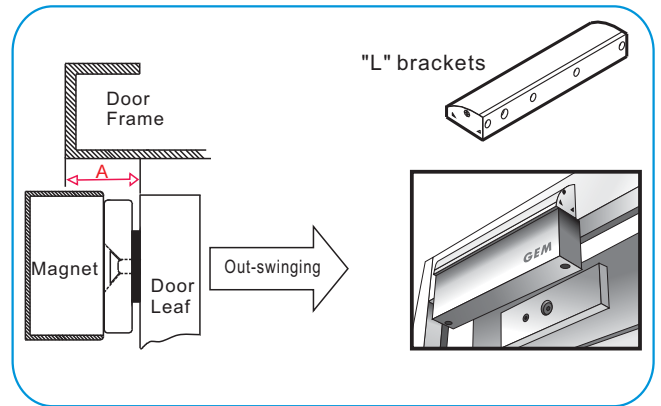

The new special styling bracket enables more aesthetic for the doors.



■ Application for the Electromagnet:
10010, 10060 (Double) Series

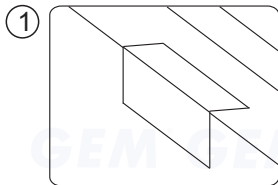
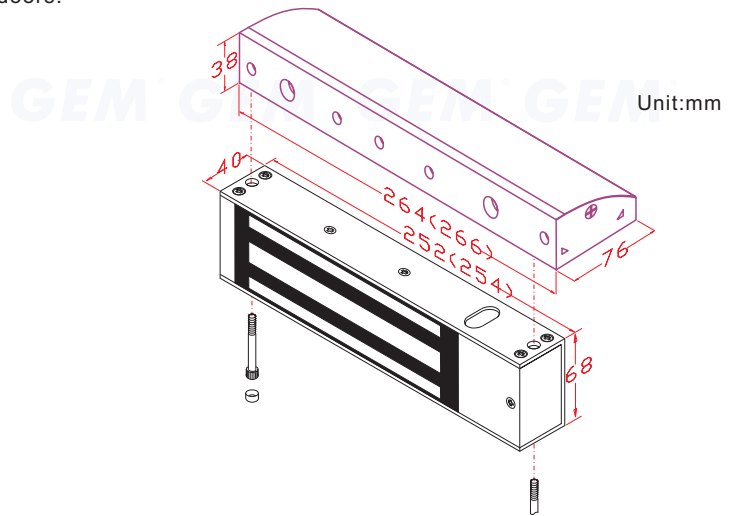

1 Fold the mounting template along the dotted line to a 90-degree angle. Close the door, place the template against the door and frame.

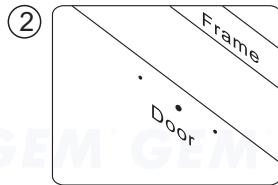

2 Drill three holes in the door as indicated on the template.

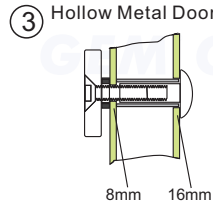

3 Hollow Metal Door
Drill an 8 mm hole through door, from sexnut bolt side only, enlarge the 8mm hole to 16mm.

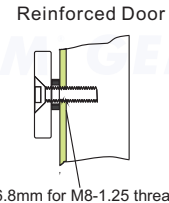

Reinforced Door
Drill an 6.8 mm dia. Hole and tap for M8x12.5 thread.

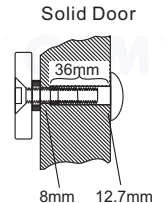

Solid Door
Drill an 8 mm hole thru door from sexnut bolt side of door, drill 12.7mm hole, 36mm in depth.

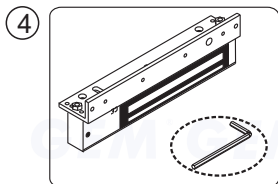

4 Use the Allen wrench to tighten the screws into the L bracket.

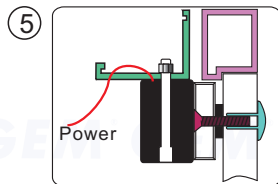

5 Turn on the power of EM-Lock, and let the armature plate bonds to the EM-lock. Adjust the position between the L bracket and the door frame.

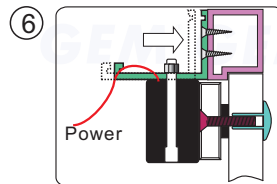

6 Once the position is correct, use the screws to permanently mount the L bracket on the door frame.

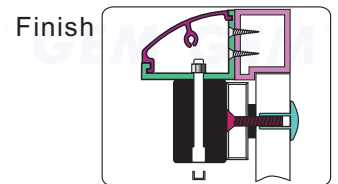

Finish
Test the unit. Insert the anti-tamper caps into the mounting screw access holes.

GIANNI INDUSTRIES, INC.

No. 13, Zhong Sing Road, Tu-Cheng Industrial Zone,
Tu-Cheng City, Taipei, Taiwan 23678
Tel: 886-2 2267 7986 / Fax: 886-2 2267 9876
E-Mail: info@gianni.com.tw
Website: gianni.tw
Copyright 2008 Gianni industries, inc. All rights reserved.
DM-CA-L-10010N Ver. B Published on 2008.05.30



The products are manufactured under an ISO 9001 & QC 080000 Certified Quality Management Program environment back its product quality, performance and commitment to customer satisfaction.